

COLLAPSIBLE PLANE-R-BOARD™

Side planer boards add another dimension to fishing — especially valuable when schooling or surface fish are spooky.

The Cannon Plane-R-Board was developed to provide outstanding performance regardless of wave conditions — It won't flip or dive, even in the roughest water. It also embodies these additional benefits:

- Easy to assemble — no tools required.
- One unit works on both port and starboard.
- Ballast engineered-in — no need to mess with filling and emptying water compartment.
- The rugged Ethafoam "boards" can't shatter or crumble... have excellent compression/distortion recovery.
- Ethafoam is also lightweight, waterproof, petroleum- and chemical-resistant, nonabrasive, and permanently buoyant.
- Rust- and corrosion-resistant hardware.

Using Your Plane-R-Board

The key to control of the Plane-R-Board is to keep the tow line out of the water. The distance your Plane-R-Board can be from the boat is directly related to the height of your tow line as well as sea conditions. For easiest deployment and retrieval of your Plane-R-Board, use a Cannon Plane-R-Reel™. Made in standard and elite models, these reels have a built-in clutch/lock; they provide safe, neat towline storage, and let you crank in your Plane-R-Boards quickly and easily. Plane-R-Reels can be fastened directly to your boat, or to a Cannon Plane-R-Boom™ as pictured.

Tie a swivel clip to the end of your towline. For starboard trolling (right side of boat, facing bow), clip towline to the top eyelet. For port side trolling, simply flip the Plane-R-Board over and clip towline to the top eyelet. Whichever direction the Plane-R-Board is used always clip the towline to the top eyelet.

To start trolling, pull out several feet of towline and toss board into water slightly away from side of boat. Then unreel the desired length of towline to fit fishing conditions and the number of lines you plan to fish. (Most reels come with up to 150 feet of towline).

CAUTION: You should never attempt planer board fishing in congested areas because it is too easy for other boats to cut across your lines — or even cut your towline. (Cannon towline is fluorescent yellow to help prevent this from happening.)

CAUTION: Conditions will exist where Plane-R-Boards cannot be used. Use caution.

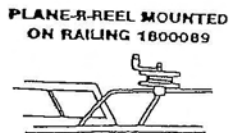
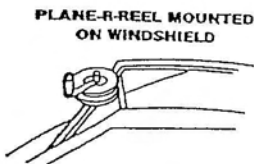

PLANE-R-REEL SHOULD BE MOUNTED TOWARD BOW OF BOAT

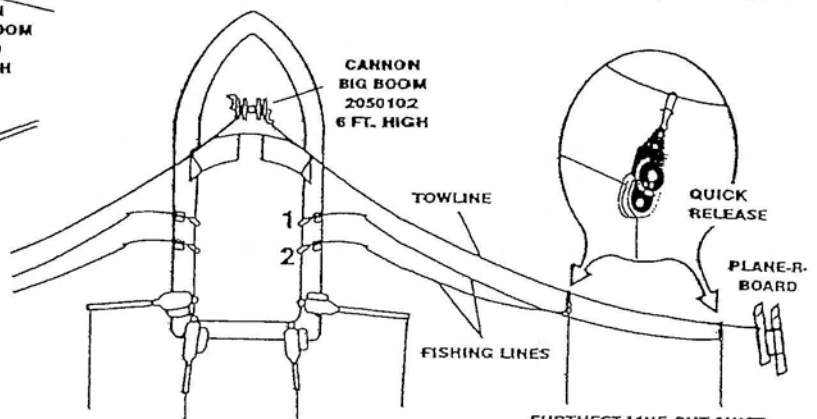
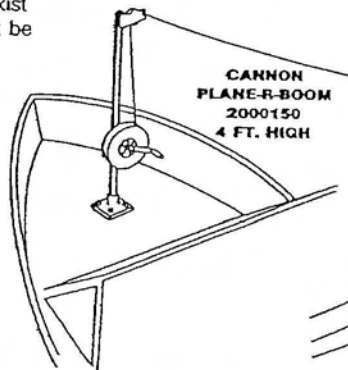

FURTHEST LINE OUT MUST STAY ON TOP IN ORDER TO CLEAR THE INSIDE LINES WHEN RELEASED. ROD 1 OVER ROD 2

PLANE-R-BOOM — 4' one-reel model: No. 2000150
BIG BOOM — 6' two-reel model: No. 2050102



DOWNRIGGERS DESIGNED BY FISHERMEN
Division of Armstrong International

CANNON / S & K Products, Inc.
1732 Glade Street Muskegon, Michigan 49441

Made in U.S.A.
Copyright 1967, S & K Products, Inc. All rights reserved.

Form No. 2281139

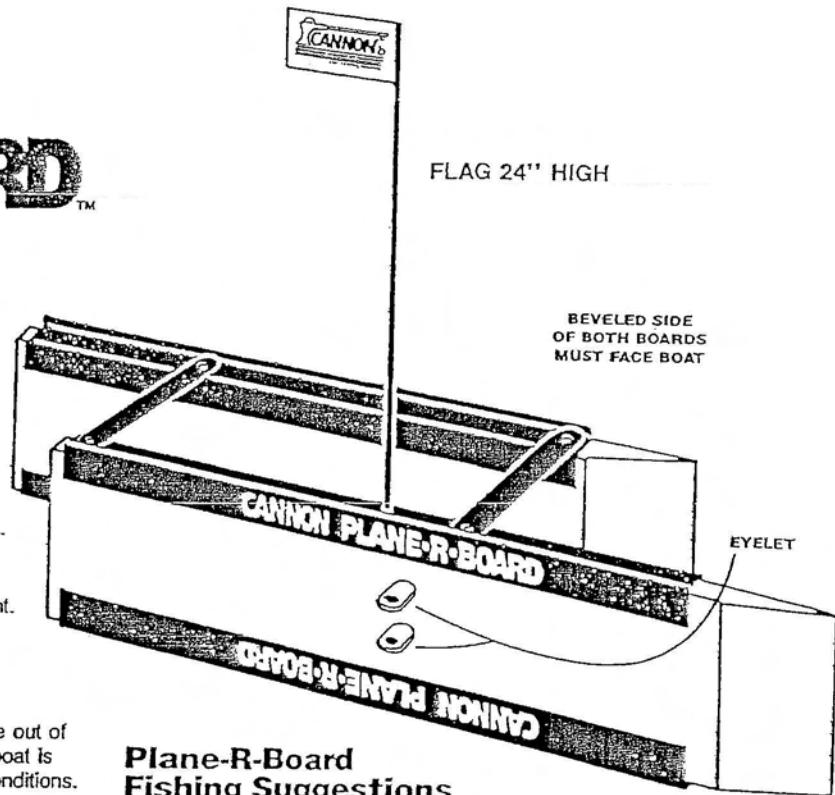

Plane-R-Board Fishing Suggestions

You can use one Plane-R-Board, on either side of your boat, or two at once — one on each side...And you can fish one line or several lines off each Board. Cannon's adjustable-tension Quick Release™ is ideal for this purpose: 1) Unreel the length of fishing line you want to troll, 2) Slip the line between the Quick Release gripper pads, 3) Adjust the tension to fit your line weight and the release force you prefer, 4) Fasten the clip over the Plane-R-Board towline, and 5) Let it play out to the distance from the boat you want to troll that lure.

The fishing line furthest out must be deployed first, of course. Be sure that the next line(s) deployed go *underneath* the first, to prevent tangling when you get a strike.

Mounting Your Flag

Grasp the stem and push firmly into the 1/8" dia. hole located on the top rail of the inward board only. The pointed tip of the stem will make its own hole in the Ethafoam the first time used and will hold firmly even after removing and inserting thousands of times. If the flag is lost or damaged your dealer may have or order part #172931 (C3032).

Line Tie Bracket Assembly

The only assembly required is to push the line tie bracket through the holes provided on the inward board. It must be placed as pictured above.

CANNON PLANE-R-BOARD

COLLAPSIBLE Part No. 1750510

Side planer boards add another dimension to fishing – especially valuable when schooling or surface fish are spooky.

The CANNON Plane-R-Board was developed to provide outstanding performance regardless of wave conditions – It won't flip or dive, even in the roughest water. It also embodies these additional benefits:

- Fully assembled – no tools required.
- One unit works on both port and starboard.
- Ballast engineered-in – no need mess with filling and emptying water compartment
- Rust- and corrosion-resistant hardware.

Using Your Plane-R-Board

The Cannon Plane-R-Board has been designed for maximum efficiency. However, varying wave condition can affect that efficiency.

Be sure the screws holding the strut bars are tight enough so the Plane-R-Board cannot fold by gravity alone.

The key to control of the Plane-R-Board is to keep the tow line out of the water. The distance your Plane-R-Board can be from the boat is directly related to the height of your tow line as well as sea conditions. For easiest deployment and retrieval of your Plane-R-Board, use a Cannon Plane-R-Reel™. These reels have a built-in clutch/lock; they provide safe, neat towline storage, and let you crank in your Plane-R-Boards quickly and easily. Plane-R-Reels can be fastened directly to your boat, or to a Cannon Plane-R-Boom™ as pictured.

Tie a snap swivel to the end of your towline and clip to the towing eyelet of the board. To start trolling pull out several feet of towline, and toss the board into the water with the angled ends forward and slightly away from the side of the boat. Unreel the desired length of towline to fit fishing conditions and the number of lines you plan to fish. (CANNON reels come with 150 feet of towline.)

CAUTION: You should never attempt planer board fishing in congested areas because it is too easy for other boats to cut across your lines – or even cut your towline. (CANNON towline is fluorescent yellow to help prevent this from happening.)

CAUTION: Conditions will exist where Plane-R-Boards cannot be used. Use caution.

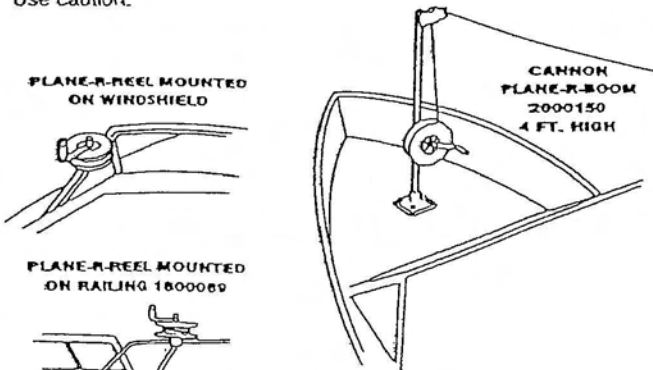

PLANE-R-REEL SHOULD BE MOUNTED TOWARD BOW OF BOAT

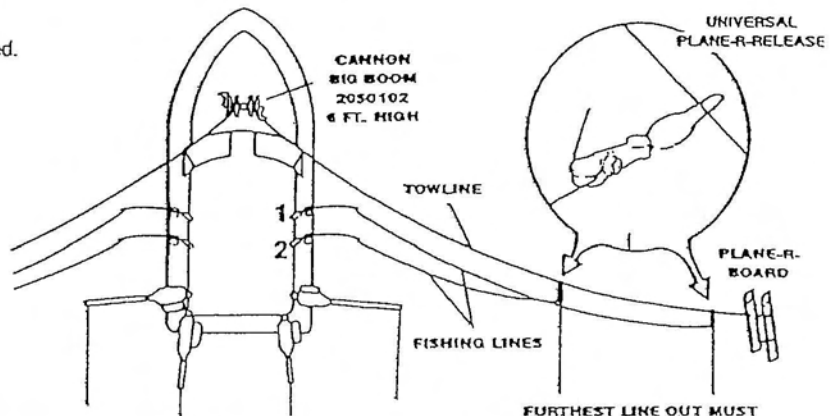

PLANE-R-BOOM — 4' one-reel model: No. 2000150
BIG BOOM — 6' two-reel model: No. 2050102

FURTHEST LINE OUT MUST STAY ON TOP IN ORDER TO CLEAR THE INSIDE LINES WHEN RELEASED.
ROD 1 OVER ROD 2

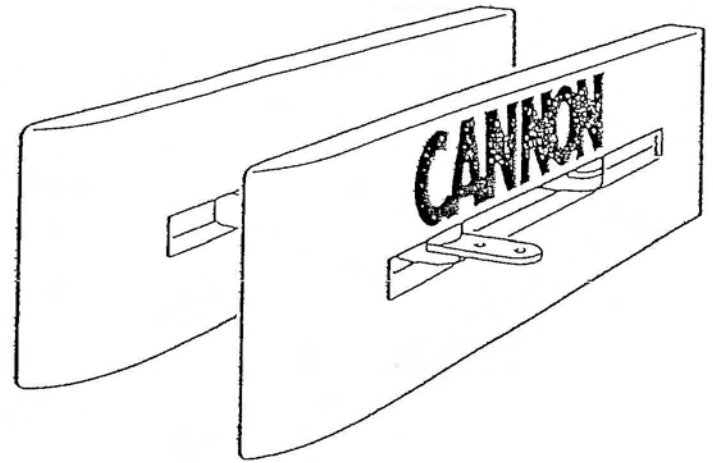

Plane-R-Board Fishing Suggestions

You can use one Plane-R-Board, on either side of your boat, or two at once – one on each side. And you can fish one line or several lines off each board. CANNON's adjustable-tension Plane-R-Release is ideal for this purpose: 1) Unreel the length of fishing line you want to troll, 2) Slip the line between the gripper pads, 3) Adjust the tension to fit your line weight and the release force you prefer, 4) Fasten the clip over the Plane-R-Board towline, and 5) Let it play out to the distance from the boat you want to troll that lure.

The fishing line furthest out must be deployed first, of course. Be sure that the next line(s) deployed go *underneath* the first, to prevent tangling when you get a strike.



CANNON/COMPUTROL INC.
499 E. Corporate Drive, Meridian, ID 83642
©1991 Computrol. All rights reserved.
Made in U.S.A. Form No. 1781001 Rev. 2/91